

SPICE thermal model

BUK7Y12-40E

Symbol	Parameter	Conditions	Min	Typ	Max	Unit
$R_{th(j-mb)}$	thermal resistance from junction to mounting base		-	-	2.33	K/W

C_{th1}	1.993E-05 F
C_{th2}	1.264E-04 F
C_{th3}	1.426E-04 F
C_{th4}	1.161E-03 F
C_{th5}	1.319E-03 F
C_{th6}	6.312E-03 F
C_{th7}	5.338E-02 F
R_{th1}	4.496E-03 Ω
R_{th2}	9.682E-03 Ω
R_{th3}	6.029E-02 Ω
R_{th4}	9.643E-02 Ω
R_{th5}	5.255E-01 Ω
R_{th6}	1.425E+00 Ω
R_{th7}	2.066E-01 Ω

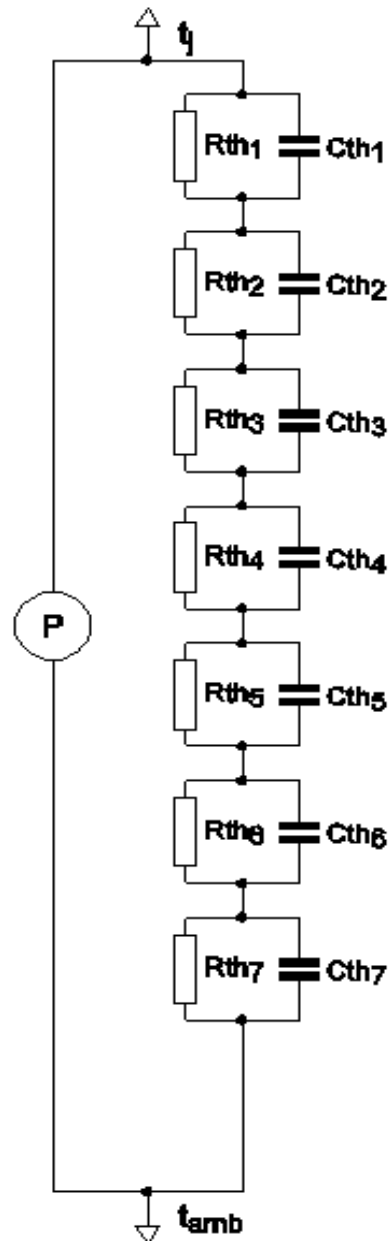

Part: BUK7Y12-40E
 Date: 25/1/2013
 Rth 2.33 K/W